



## Machine Vision Light Bracket

As a leading innovator in the Machine Vision Industry, CEI is proud to introduce our new line of Machine Vision light brackets for demanding vision applications.

### Iris GTR Light Bracket Key Features

- Available in two sizes: short and long
- Focusing & optics removal without disassembly
- Easy-open dust cover protection
- Excellent heat dissipation
- Tailored for a specific range of Lights & Optics
- Single point Swivellink mounting
- High quality windows by Midwest Optics
- Lightweight aluminum construction
- Type 2 anodizing
- Made in USA



### Light Bracket Specs\*

**CEI part number E-GTR-02S ( Short version )**

**CEI part number E-GTR-02L ( Long version )**

*CEI Design Variation:* "U" aperture long

*Camera:* Matrox Iris GTR Smart Camera Series

*Supported Optics:* See appendix table "A"

*Supported Lights:* See appendix table "B"

*Window:* Midwest Optics Acrylic AR coated (AC380-46)

*Mounting:* M5 tapped holes for Swivellink SLM-1

*Sealing:* Full Dust Cover and Window

*Material:* 6061 Aluminum

*Coating:* Type 2 anodized

*Length:*

Long: 76.20 mm (Light bracket only)  
126.73 mm (with Camera & Light Plate)

Short: 50.80 mm (Light bracket only)  
101.33 mm (with Camera & Light Plate)

*Height:* 84.84 mm (Light plate only)

*Width:* 82.06 mm (Light plate only)

*Window Diameter:* 46 mm

*Light Plate Dimensions:* 120.65 mm x 85.73 mm

*Weight:* Long: 48 g, Short: 44 g

*(W/O Camera, Optics, Light, or Mount)*

*\*Optics, Lights, and Mount dealer supplied*

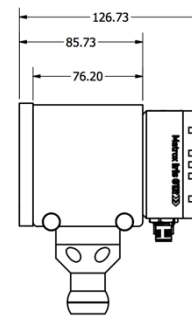

**E-GTR-02L  
(Long version)**

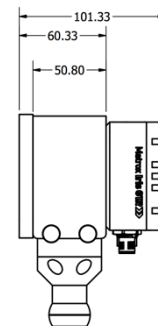
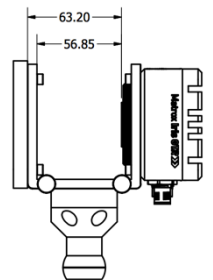

**E-GTR-02S  
(Short version)**

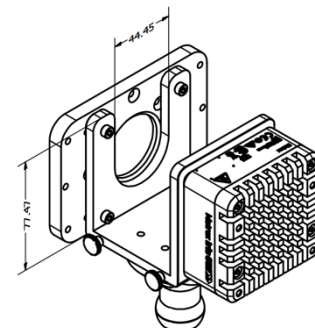
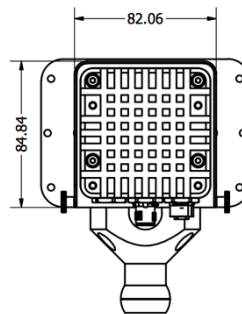
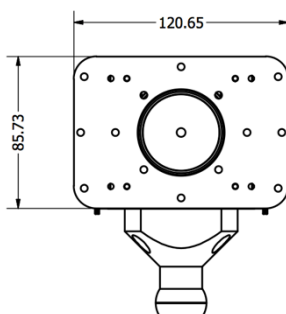
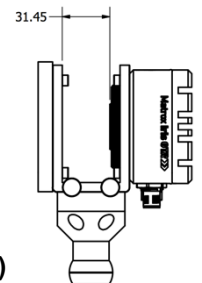

**CEI part numbers E-GTR-02S, E-GTR-02L**

**Table “A” - Supported Optics**

Format	Model	Length (mm)	E-GTR-02S	E-GTR-02L
2/3”	Computar M0814-MP2	28.2	x	
	Computar M1214-MP2	28.2	x	
	Computar M1614-MP2	28.2	x	
	Computar M2514-MP2	36	x	
	Computar M3514-MP	38.2		x
	Computar M5018-MP2	38.2		x
	Computar M7528-MP *	57.75		x
	Computar M3Z1228C-MP	57.2		x
	VariOptic C-C-39N0-160-I2C	47.7		x
	VariOptic C-C-39N0-250-I2C	47.7		x
1.1”	Computar V0828-MPY	54.3		x
	Computar V1228-MPY	37.25	x	
	Computar V1628-MPY	36.35	x	
	Computar V2528-MPY	37.7	x	
	Computar V3528-MPY	53.95		x
	Computar V5028-MPY	53.95		x

\* 6mm spacer kit (optional, not included) CEI Part No. E-GTR-KIT-06 may be required for full lens extension.

**Table “B” - Supported Lights**

Model	Diameter
RC130	130mm
R80	80 mm
R130	130mm
RD80	80mm
RD130	130mm
RCC130	130mm
RM75	75 mm
RM140	140 mm

- Ask about additional CEI Machine Vision products:**
- Mounts, Visors, Air Curtains, Windows, Filters, Cables
  - Custom Sizes, Lengths, and Focusing Solutions.
  - Complete Solutions (Camera, Enclosure, Cabling)

